







20 002 706

- avec structure CASCADE
- diamètre de percement 32 mm
- avec marquage chaud
- rosace 60 x 60 mm



| | | |
|---|-----------------------------|---------------|
|  | Chrome | 20 002 706-00 |
|  | Platine brossé | 20 002 706-06 |
|  | Dark Chrome | 20 002 706-19 |
|  | Champagne brossé (Or 22cts) | 20 002 706-46 |
|  | Champagne (Or 22cts) | 20 002 706-47 |
|  | Dark Platinum brossé | 20 002 706-99 |

20 002 706

mm [inches]



Diagramme de débit



Certificats

IAPMO_4976 (5). WRAS_2103001. LGA_28688.

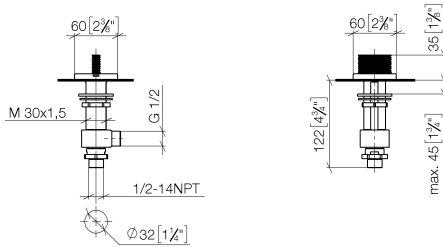
20 002 706

Les pièces pour les autres finitions peuvent être trouvées ici : Platine brossé

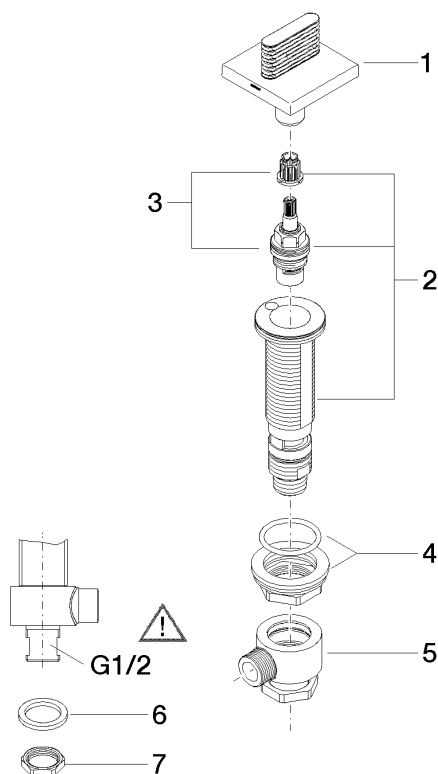

Liste des pièces de rechange

| N° | Article Numéro | Désignation | Fréquence de montage | Délai de livraison |
|----|--------------------|------------------|----------------------|--------------------|
| 1 | 90 20 70 053 05-00 | poignée (hot) | 1 | 10 |
| 2 | 04 17 11 058 32 90 | partie latérale | 1 | 2 |
| 3 | 90 90 03 132 00 90 | tête céramique | 1 | 2 |
| 4 | 04 23 10 032 78 90 | set de fixation | 1 | 2 |
| 5 | 04 17 11 023 10 90 | raccord multiple | 1 | 2 |
| 6 | 90 23 30 040 00-00 | joint américain | 1 | 10 |
| 7 | 09 30 11 059 90 | rondelle | 1 | 2 |
| 8 | 09 23 10 012 90 | écrou | 1 | 2 |